

Article number: 2310431151

Description: E+G Levelling elements  
LX.30-SW17-SST-M6X24

## Measures

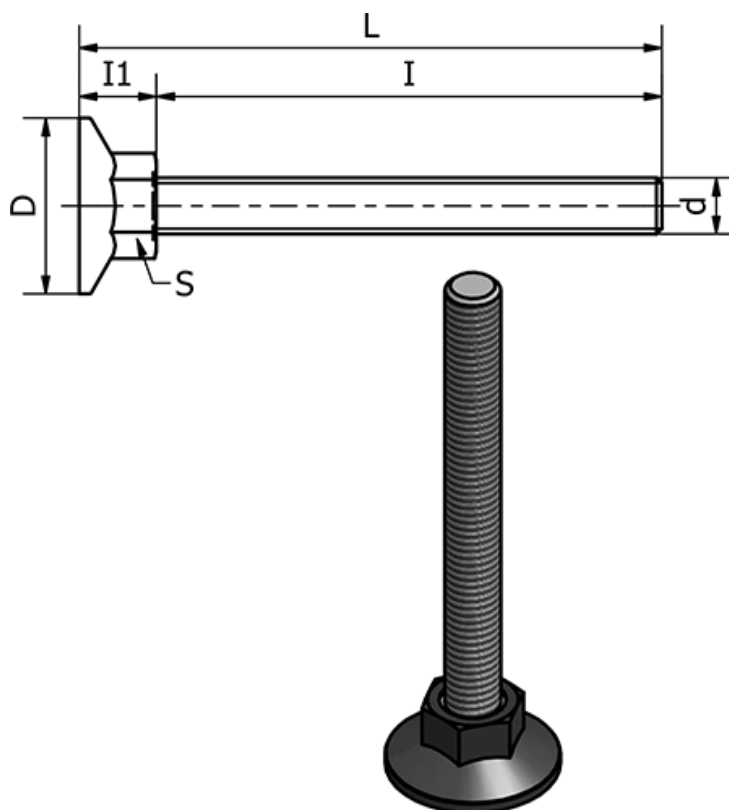

d = M6

D = 30

I = 24

I1 = 12

L = 34

S = 17

Static load in (N) = 1500

Type = AISI 304 Rustfast

Weight (g) = -